



2022
EQUINOX

Loved for all the right reasons.

The Chevrolet Equinox has earned a place in the hearts of American drivers as a compact SUV that's easy to drive and easy to love. For 2022, Equinox offers a sporty new RS model as well as new front and rear fascias, enhanced interiors and new wheel designs. More important, every 2022 Equinox comes standard with Chevy Safety Assist¹, a comprehensive package of driver assistance features that offers peace of mind on the road.

Equinox is everything you need, to do everything you want.



Equinox RS in Cherry Red Tintcoat (extra-cost color) with available features.

¹ Chevy Safety Assist includes Automatic Emergency Braking, Front Pedestrian Braking, Lane Keep Assist with Lane Departure Warning, Forward Collision Alert, IntelliBeam and Following Distance Indicator. Safety or driver assistance features are no substitute for the driver's responsibility to operate the vehicle in a safe manner. Read the vehicle Owner's Manual for important feature limitations and information.

INTRODUCING EQUINOX

Equinox at a glance.

- 5-passenger compact SUV
- Four models: LS, LT, RS and Premier
- Standard FWD or available AWD
- 60/40 split-folding rear seats
- Up to 63.9 cubic feet¹ of storage space with rear seats folded
- 1.5L turbocharged DOHC 4-cylinder engine with 170 horsepower and 203 lb.-ft. of torque
- Chevy Safety Assist,² standard on all models, includes
 - Automatic Emergency Braking
 - Front Pedestrian Braking
 - Lane Keep Assist with Lane Departure Warning
 - Forward Collision Alert
 - IntelliBeam®
 - Following Distance Indicator



Equinox Premier in Blue Glow Metallic with available features.



60/40 split-folding rear seats offer extra cargo flexibility.

¹ Cargo and load capacity limited by weight and distribution. ² Safety or driver assistance features are no substitute for the driver's responsibility to operate the vehicle in a safe manner. Read the vehicle Owner's Manual for important feature limitations and information.

MODELS

Four models to choose from.

There's an Equinox for every driving taste.



LS

A comprehensively equipped Equinox with almost everything you can imagine.

- LED headlamps
- Wireless Apple CarPlay^{®1} and wireless Android Auto^{™2} compatibility
- Outside heated power-adjustable manual-folding mirrors
- Available Driver Confidence II Package includes Rear Cross Traffic Alert³, Lane Change Alert with Side Blind Zone Alert³ and Rear Park Assist³
- Chevrolet Infotainment 3 system⁴ with 7-inch diagonal color touch-screen
- USB ports⁵ and auxiliary input jack
- Available Wi-Fi[®] Hotspot⁶
- Teen Driver technology
- 12-volt auxiliary power outlets in front storage bin and in rear cargo area



LT

Make yourself at home while you're out taking care of business.

- Body-color mirror caps
- Deep-tinted rear glass
- Bright lower window trim
- Available bright roof rails
- 8-way power driver seat with power lumbar control
- Second-row mechanical seat release levers in cargo area
- Available Confidence & Convenience Package includes dual-zone automatic climate control, remote vehicle starter system, programmable power liftgate, Rear Cross Traffic Alert³, Front and Rear Park Assist³ and more



RS

New for 2022, RS puts a little street attitude behind the daily demands.

- Blacked-out grille and surround with Red RS badging plus Black Chevrolet bowtie emblems and Equinox badging
- 19-inch Dark Android-painted wheels
- Programmable power liftgate
- LED taillamps
- Unique RS interior with Red stitching and Black Ice chrome accents
- Leather-wrapped steering wheel
- Dual-zone automatic climate control
- Lane Change Alert with Side Blind Zone Alert³
- Front and Rear Park Assist³
- Rear Cross Traffic Alert³
- Remote vehicle starter system



Premier

Sometimes we just want more style and luxury – the complete package.

- Outside heated power-adjustable body-color manual-folding mirrors with integrated turn signal indicators
- 18-inch machined-face wheels
- Hands-free power liftgate with Chevrolet emblem projection
- Fog lamps
- Leather-appointed seating
- Heated leather-wrapped steering wheel
- Memory settings for driver seat and outside rearview mirrors
- Chevrolet Infotainment 3 Plus system⁴ with 8-inch diagonal color touch-screen
- USB ports⁵ in floor console storage bin
- Wireless charging⁷

¹ Vehicle user interface is a product of Apple and its terms and privacy statements apply. Requires compatible iPhone and data plan rates apply. ² Vehicle user interface is a product of Google and its terms and privacy statements apply. Requires the Android Auto app on Google Play and a compatible Android smartphone. Data plan rates apply. You can check which smartphones are compatible at g.co/androidauto/requirements. ³ Safety or driver assistance features are no substitute for the driver's responsibility to operate the vehicle in a safe manner. Read the vehicle Owner's Manual for important feature limitations and information. ⁴ Chevrolet Infotainment System functionality varies by model. Full functionality requires compatible Bluetooth and smartphone, and USB connectivity for some devices. ⁵ Not compatible with all devices. ⁶ Service varies with conditions and location. Requires active service and paid AT&T data plan. Visit onstar.com for details and limitations. ⁷ The system wirelessly charges one compatible mobile device. Some phones have built-in wireless charging technology and others require a special adaptor/back cover. To check for phone or other device compatibility, visit my.chevrolet.com/learn or consult your carrier.

Apple CarPlay, iPhone, Siri and Apple Music are trademarks of Apple Inc., registered in the U.S. and other countries. Android, Google Play and Android Auto are trademarks of Google LLC.

LS EXTERIOR COLORS



Summit White



Silver Ice Metallic



Iron Gray Metallic



Blue Glow Metallic



Mosaic Black Metallic

LS FEATURES



Select standard features:

MECHANICAL

Engine – 1.5L turbocharged DOHC 4-cylinder with Variable Valve Timing (VVT), Direct Injection and Automatic Stop/Start

StabiliTrak® – Electronic Stability Control System with Traction Control

Transmission – 6-speed automatic, electronically controlled with overdrive and Driver Shift Control

EXTERIOR

Glass – solar-absorbing tinted; acoustic-laminated windshield

Headlamps – LED, automatic on/off with automatic delay

Mirrors – heated, power-adjustable, manual-folding with Black caps

INTERIOR

Air conditioning – manual, single-zone

Cruise control – electronic with Set and Resume Speed

Entertainment – Chevrolet Infotainment 3 system¹ with 7-inch diagonal color touch-screen

Keyless Open and Start – includes extended-range Remote Keyless Entry

Media – USB ports²; one Type-A and one Type-C, and auxiliary input jack in front storage bin; two USB ports²; Type-A, charge-only, on rear of center console

Rear Vision Camera³

SiriusXM^{®4} – 3-month trial subscription

Steering column – manual tilt and telescopic

Steering wheel – 3-spoke with mounted audio, cruise and phone controls

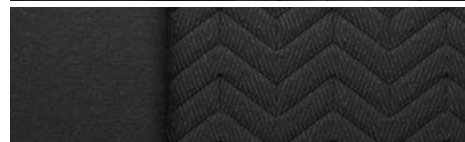

Medium Ash Gray Premium Cloth



17" Bright Silver-Painted Aluminum Wheels
Standard on LS

¹ Chevrolet Infotainment System functionality varies by model. Full functionality requires compatible Bluetooth and smartphone, and USB connectivity for some devices. ² Not compatible with all devices. ³ Safety or driver assistance features are no substitute for the driver's responsibility to operate the vehicle in a safe manner. Read the vehicle Owner's Manual for important feature limitations and information. ⁴ If you decide to continue service after your trial, your selected subscription plan will automatically renew thereafter. You will be charged at then-current rates. Fees and taxes apply. To cancel you must call SiriusXM at 1-866-635-2349. See SiriusXM Customer Agreement for complete terms at siriusxm.com. All fees and programming subject to change.

LT EXTERIOR COLORS



Summit White



Iridescent Pearl Tricoat¹



Silver Ice Metallic



Iron Gray Metallic



Cherry Red Tintcoat¹



Seaglass Blue Metallic



Blue Glow Metallic



Mosaic Black Metallic

¹Extra-cost color.

LT FEATURES



Select standard features:

MECHANICAL

Engine – 1.5L turbocharged DOHC 4-cylinder with Variable Valve Timing (VVT), Direct Injection and Automatic Stop/Start

Transmission – 6-speed automatic, electronically controlled with overdrive and Driver Shift Control

EXTERIOR

Glass – solar-absorbing tinted and deep-tinted rear windows; acoustic-laminated windshield

Headlamps – LED, automatic on/off with automatic delay

Mirrors – heated, power-adjustable, manual-folding with body-color caps

INTERIOR

Air conditioning – manual, single-zone

Cruise control – electronic with Set and Resume Speed

Entertainment – Chevrolet Infotainment 3 system¹ with 7-inch diagonal color touch-screen

Keyless Open and Start – includes extended-range Remote Keyless Entry

Media – USB ports²; one Type-A and one Type-C, and auxiliary input jack in front storage bin; two USB ports² Type-A, charge-only, on rear of center console

Rear Vision Camera³

Seat release – second-row mechanical levers in cargo area

Seats – driver 8-way power adjuster with 2-way power lumbar control

SiriusXM^{®4} – 3-month trial subscription

Steering column – manual tilt and telescopic

Steering wheel – 3-spoke with mounted audio, cruise and phone controls

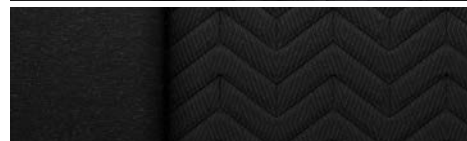

Jet Black Premium Cloth (shown)

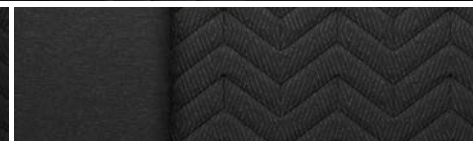

Medium Ash Gray Premium Cloth



17" Bright Silver-Painted Aluminum Wheels
Standard on LT



18" Machined-Face Aluminum Wheels
with Charcoal-Painted Pockets
Available on LT

¹ Chevrolet Infotainment System functionality varies by model. Full functionality requires compatible Bluetooth and smartphone, and USB connectivity for some devices. ² Not compatible with all devices. ³ Safety or driver assistance features are no substitute for the driver's responsibility to operate the vehicle in a safe manner. Read the vehicle Owner's Manual for important feature limitations and information. ⁴ If you decide to continue service after your trial, your selected subscription plan will automatically renew thereafter. You will be charged at then-current rates. Fees and taxes apply. To cancel you must call SiriusXM at 1-866-635-2349. See SiriusXM Customer Agreement for complete terms at siriusxm.com. All fees and programming subject to change.

RS EXTERIOR COLORS



Summit White



Iridescent Pearl Tricoat¹



Silver Ice Metallic



Iron Gray Metallic



Cherry Red Tintcoat¹



Seaglass Blue Metallic



Blue Glow Metallic



Mosaic Black Metallic

¹Extra-cost color.

RS FEATURES



Select standard features:

MECHANICAL

Engine – 1.5L turbocharged DOHC 4-cylinder with Variable Valve Timing (VVT), Direct Injection and Automatic Stop/Start

Transmission – 6-speed automatic, electronically controlled with overdrive and Driver Shift Control

EXTERIOR

Chevrolet bowtie emblems – Black

Glass – solar-absorbing tinted and deep-tinted rear windows; acoustic-laminated windshield

Liftgate – power, programmable

Roof rails – Black

Taillamps – LED

INTERIOR

Air conditioning – automatic, dual-zone with individual climate settings for driver and front passenger

Cruise control – electronic with Set and Resume Speed

Entertainment – Chevrolet Infotainment 3 system¹ with 7-inch diagonal color touch-screen

Rear Vision Camera²

Remote vehicle starter system

Seat – driver 8-way power adjuster with power lumbar control

SiriusXM^{®3} – 3-month trial subscription

Steering column – manual tilt and telescopic

Steering wheel – 3-spoke, leather-wrapped with mounted audio, cruise and phone controls

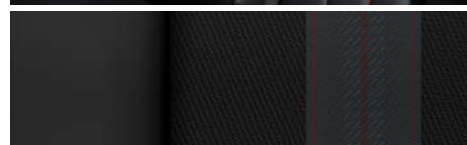

Jet Black Premium Cloth with Red Accents

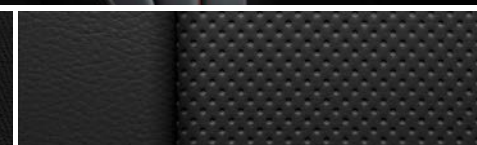

Jet Black Leather-Appointed Seating Surfaces with Red Accents (shown)⁴



19" Dark Android-Painted Aluminum Wheels
Standard on RS

¹ Chevrolet Infotainment System functionality varies by model. Full functionality requires compatible Bluetooth and smartphone, and USB connectivity for some devices. ² Safety or driver assistance features are no substitute for the driver's responsibility to operate the vehicle in a safe manner. Read the vehicle Owner's Manual for important feature limitations and information. ³ If you decide to continue service after your trial, your selected subscription plan will automatically renew thereafter. You will be charged at then-current rates. Fees and taxes apply. To cancel you must call SiriusXM at 1-866-635-2349. See SiriusXM Customer Agreement for complete terms at siriusxm.com. All fees and programming subject to change. ⁴ Requires available RS Leather Package.

Some features shown may have limited, late or no availability. See dealer for feature availability.

PREMIER EXTERIOR COLORS



Summit White



Iridescent Pearl Tricoat¹



Silver Ice Metallic



Iron Gray Metallic



Cherry Red Tintcoat¹



Seaglass Blue Metallic



Blue Glow Metallic



Mosaic Black Metallic

¹Extra-cost color.

PREMIER FEATURES



Select standard features:

MECHANICAL

Engine – 1.5L turbocharged DOHC 4-cylinder with Variable Valve Timing (VVT), Direct Injection and Automatic Stop/Start

Transmission – 6-speed automatic, electronically controlled with overdrive and Driver Shift Control

EXTERIOR

Fog lamps

Liftgate – power, programmable, hands-free with Chevrolet emblem projection

Mirrors – heated, power-adjustable, manual-folding with body-color caps and integrated turn signal indicators

Roof rails – bright

Taillamps – LED

INTERIOR

Air conditioning – automatic, dual-zone with individual climate settings for driver and front passenger

Cruise control – electronic with Set and Resume Speed

Entertainment – Chevrolet Infotainment 3 Plus system¹ with 8-inch diagonal HD color touch-screen

HD Rear Vision Camera²

Power outlet – 120-volt on rear of center console

Remote vehicle starter system

SiriusXM^{®3} – 3-month trial subscription

Steering column – manual tilt and telescopic

Steering wheel – 3-spoke, leather-wrapped, heated with mounted audio, cruise and phone controls



Jet Black Perforated Leather-Appointed Seating Surfaces



Jet Black/Maple Sugar Perforated Leather-Appointed Seating Surfaces⁴ (shown)



18" Machined-Face Aluminum Wheels with Charcoal-Painted Pockets Standard on Premier



19" Aluminum Wheels Available on Premier

¹ Chevrolet Infotainment System functionality varies by model. Full functionality requires compatible Bluetooth and smartphone, and USB connectivity for some devices. ² Safety or driver assistance features are no substitute for the driver's responsibility to operate the vehicle in a safe manner. Read the vehicle Owner's Manual for important feature limitations and information. ³ If you decide to continue service after your trial, your selected subscription plan will automatically renew thereafter. You will be charged at then-current rates. Fees and taxes apply. To cancel you must call SiriusXM at 1-866-635-2349. See SiriusXM Customer Agreement for complete terms at siriusxm.com. All fees and programming subject to change. ⁴ Not available with Cherry Red Tintcoat exterior color.

SPECIFICATIONS

● STANDARD ○ AVAILABLE – NOT AVAILABLE

	LS	LT	RS	PREMIER
SAFETY AND DRIVER ASSISTANCE				
Chevy Safety Assist ¹	●	●	●	●
Automatic Emergency Braking	●	●	●	●
Front Pedestrian Braking	●	●	●	●
Lane Keep Assist with Lane Departure Warning	●	●	●	●
Forward Collision Alert	●	●	●	●
IntelliBeam, auto high beams	●	●	●	●
Following Distance Indicator	●	●	●	●
Airbags ² – frontal and seat-mounted side-impact airbags for driver and front passenger; head-curtain airbags for all outboard seating positions; includes Passenger Sensing System for frontal passenger airbag	●	●	●	●
Lane Change Alert with Side Blind Zone Alert ¹ (requires available Driver Confidence II Package on LS; requires available Confidence & Convenience Package on LT)	○	○	●	●
LATCH system (Lower Anchors and Tethers for CHildren) – for child restraint systems	●	●	●	●
Rear Cross Traffic Alert ¹ (requires available Driver Confidence II Package on LS; requires available Confidence & Convenience Package on LT)	○	○	●	●
Rear Park Assist ¹ (requires available Driver Confidence II Package)	○	–	–	–
Front and Rear Park Assist ¹ (requires available Confidence & Convenience Package on LT)	–	○	●	●
Automatic Parking Assist ¹ (requires available Confidence & Convenience II Package)	–	–	–	○
Rear Vision Camera ¹	●	●	●	–
HD Rear Vision Camera ¹ (requires available Confidence & Convenience Package, Advanced Safety Package and Infotainment Package on LT; requires available Advanced Safety Package and Infotainment Package on RS)	–	○	○	●
HD Surround Vision ¹ (requires available Confidence & Convenience Package, Advanced Safety Package and Infotainment Package on LT; requires available Advanced Safety Package and Infotainment Package on RS; requires available Confidence & Convenience II Package on Premier)	–	○	○	○
Safety Alert Seat ¹	–	–	–	●
Teen Driver technology	●	●	●	●
Theft-deterrent system – unauthorized entry	●	●	●	●
Tire Pressure Monitoring System – with Tire Fill Alert (does not monitor spare tire)	●	●	●	●
Up to 3 months of OnStar [®] Safety & Security coverage ³	●	●	●	●
MECHANICAL				
All-wheel drive – on/off switchable	○	○	○	○
Brakes – 4-wheel antilock, 4-wheel disc with Duralife [®] rotors; electronic parking brake	●	●	●	●

	LS	LT	RS	PREMIER
MECHANICAL (CONTINUED)				
Engine – 1.5L turbocharged DOHC 4-cylinder with Variable Valve Timing (VVT), Direct Injection and Automatic Stop/Start; 170 hp @ 5600 rpm, 203 lb.-ft. of torque @ 2000–4000 rpm	●	●	●	●
Exhaust – aluminized stainless steel	●	●	●	●
StabiliTrak – Electronic Stability Control System with Traction Control; includes Hill Start Assist	●	●	●	●
Steering – power, electric, rack-and-pinion	●	●	●	●
Suspension – front MacPherson strut – rear 4-link, independent	●	●	●	●
Transmission – 6-speed automatic, electronically controlled with overdrive and Driver Shift Control	●	●	●	●
EXTERIOR				
Active aero shutters	●	●	●	●
Antenna – Black	●	●	●	–
– body-color	–	–	–	●
Chevrolet bowtie emblems – Black	–	–	●	–
Daytime running lamps – reduced intensity low beam – LED	●	–	–	–
Door handles – body-color – chrome with body-color inserts	●	●	●	–
Fog lamps	–	–	–	●
Fuel filler – capless fueling	●	●	●	●
Glass – solar-absorbing; acoustic-laminated windshield – deep-tinted rear (requires available LS Convenience Package on LS)	○	●	●	●
Headlamps – LED, automatic on/off with automatic delay	●	●	●	●
Liftgate – manual – power, programmable (requires available Confidence & Convenience Package on LT) – power, programmable, hands-free with Chevrolet emblem projection	●	●	–	–
Mirrors – heated, power-adjustable, manual-folding – heated, power-adjustable, manual-folding with integrated turn signal indicators (requires available Confidence & Convenience Package, Advanced Safety Package and Infotainment Package on LT; requires available Advanced Safety Package and Infotainment Package on RS)	●	●	●	–
– Black caps – body-color caps	●	–	–	–
Roof rails – bright (requires available power sunroof on LT) – Black	–	○	–	●

¹ Safety or driver assistance features are no substitute for the driver's responsibility to operate the vehicle in a safe manner. Read the vehicle Owner's Manual for important feature limitations and information. ² A NOTE ON CHILD SAFETY: Always use seat belts and the correct child restraint for your child's age and size, even with airbags. Even in vehicles equipped with the Passenger Sensing System, children are safer when properly secured in a rear seat in the appropriate infant, child or booster seat. Never place a rear-facing infant restraint in the front seat of any vehicle equipped with an active frontal airbag. See your vehicle Owner's Manual and the child safety seat instructions for more safety information. ³ When you select a monthly plan within 30 days of activating your 1-month trial, you'll receive the next 2 months of the plan you select at no additional charge when you associate an approved payment method on file to your account and authorize recurring payments for your service plan. The amount and frequency of each recurring payment is based upon the service(s) and payment interval(s) you select from the options provided. After the trial expires, OnStar will automatically bill your payment method monthly at then-current standard monthly rates. Plans containing 4G LTE data will be billed every 30 days by AT&T. You may cancel at any time by pushing your blue OnStar button or calling 1-888-466-7827. May not be combined with other offers or retroactively applied. Offer subject to change.

SPECIFICATIONS (CONTINUED)

● STANDARD ○ AVAILABLE – NOT AVAILABLE

	LS	LT	RS	PREMIER
EXTERIOR (CONTINUED)				
Taillamps – incandescent	●	●	–	–
– LED	–	–	●	●
Tires – P225/65R17 all-season	●	●	–	–
– P225/60R18 all-season (requires available 18" wheels on LT)	–	○	–	●
– P235/50R19 all-season (requires available 19" wheels on Premier)	–	–	●	○
– compact spare	●	●	●	●
Wheels – 17" Bright Silver-painted aluminum	●	●	–	–
– 18" machined-face aluminum with Charcoal-painted pockets	–	○	–	●
– 19" Dark Android-painted aluminum	–	–	●	–
– 19" aluminum	–	–	–	○
Wipers – front variable-speed, intermittent; rear intermittent with washer	●	●	●	●
INTERIOR				
Active Noise Cancellation	●	●	●	●
Air conditioning – manual, single-zone	●	●	–	–
– automatic, dual-zone with individual climate settings for driver and front passenger (requires available Confidence & Convenience Package on LT)	–	○	●	●
Air filter – cabin	●	●	●	●
Assist handles – overhead, all outboard seating positions	●	●	●	●
Console – overhead storage for sunglasses	–	●	●	●
Cruise control – electronic with Set and Resume Speed	●	●	●	●
– Adaptive Cruise Control ¹ (requires available Confidence & Convenience Package, Advanced Safety Package and Infotainment Package on LT; requires available Advanced Safety Package and Infotainment Package on RS; requires available Confidence & Convenience II Package on Premier)	–	○	○	○
Door locks – power programmable with lockout protection and manual rear door child security	●	●	●	●
Driver Information Center – enhanced, monochromatic display	●	–	–	–
– enhanced, multi-color display (requires available LS Convenience Package on LS)	○	●	●	●
Floor mats – front and rear, carpeted	●	●	●	●
Keyless Open and Start – includes extended-range Remote Keyless Entry and panic feature	●	●	●	●
Lighting – front-seat reading lamps, overhead courtesy lamp and illuminated cargo area	●	●	●	●
Memory settings – recalls two presets for 8-way power driver seat and outside rearview mirrors	–	–	–	●
Mirror – rearview, manual day/night	●	●	●	–
– rearview, auto-dimming	–	–	–	●
Power outlets – 12-volt auxiliary, in front storage bin and rear cargo area	●	●	●	●
– 120-volt, on rear of center console (requires available Confidence & Convenience Package, Advanced Safety Package and Infotainment Package on LT; requires available Advanced Safety Package and Infotainment Package on RS)	–	○	○	●

	LS	LT	RS	PREMIER
INTERIOR (CONTINUED)				
Rear Seat Reminder ² notification	●	●	●	●
Remote vehicle starter system (requires available Confidence & Convenience Package on LT)	–	○	●	●
Steering column – manual tilt and telescopic	●	●	●	●
Steering wheel – 3-spoke with mounted audio, cruise and phone controls	●	●	●	●
– leather-wrapped, 3-spoke with mounted audio, cruise and phone controls (requires available Confidence & Convenience Package on LT)	–	○	●	●
– heated (requires available Confidence & Convenience Package, Advanced Safety Package and Infotainment Package on LT; requires available Advanced Safety Package and Infotainment Package on RS)	–	○	○	●
Sunroof – power, tilt-sliding, with fixed rear skylight and sunshade; includes bright roof rails on LT (requires available Confidence & Convenience Package on LT; requires available Confidence & Convenience II Package on Premier)	–	○	○	○
Universal Home Remote – programmable, includes garage door opener	–	–	–	●
Visors – driver and front passenger, covered vanity mirrors	●	–	–	–
– driver and front passenger, covered illuminated vanity mirrors	–	●	●	●
Windows – power with driver express-up/-down, all others express-down	●	●	●	●
SEATING				
Seats – front bucket	●	●	●	●
– rear manual-folding 60/40 split-bench with center armrest	●	●	●	●
Seat – driver 4-way manual adjuster	●	–	–	–
– front passenger 4-way manual adjuster	●	●	●	●
– driver 8-way power adjuster with 2-way power lumbar control (requires available LS Convenience Package on LS)	○	●	●	●
– front passenger 8-way power adjuster with 2-way power lumbar control (requires available Confidence & Convenience II Package)	–	–	–	○
Heated front seats (requires available Confidence & Convenience Package on LT; feature will not function on certain models without dealer retrofit; see dealer or window label for details)	–	○	○	○
Heated rear outboard seating positions (requires available Confidence & Convenience II Package; feature will not function on certain models without dealer retrofit; see dealer or window label for details)	–	–	–	○
Ventilated front seats (requires available Confidence & Convenience II Package; feature will not function on certain models without dealer retrofit; see dealer or window label for details)	–	–	–	○
Seatback pocket – front passenger	●	●	●	●
– driver (requires available RS Leather Package, Advanced Safety Package and Infotainment Package on RS)	–	–	○	●
Seat release – second-row mechanical levers in cargo area	–	●	●	●

¹ Safety or driver assistance features are no substitute for the driver's responsibility to operate the vehicle in a safe manner. Read the vehicle Owner's Manual for important feature limitations and information. ² Does not detect people or items. Always check rear seat before exiting.

SPECIFICATIONS (CONTINUED)

	LS	LT	RS	PREMIER
ENTERTAINMENT				
Chevrolet Infotainment 3 system ¹ with 7-inch diagonal color touch-screen, AM/FM stereo, Bluetooth [®] audio streaming ² for two active devices, voice command pass-through to compatible phone, and wireless Apple CarPlay ^{®3} and wireless Android Auto ^{™4} compatibility	●	●	●	-
Chevrolet Infotainment 3 Plus system ¹ and 8-inch diagonal HD color touch-screen, AM/FM stereo, Bluetooth audio streaming ² for two active devices, voice command pass-through to compatible phone, wireless Apple CarPlay ³ and wireless Android Auto ⁴ compatibility, available Alexa Built-In ⁵ ; voice recognition, available In-Vehicle Apps ⁶ and Chevrolet Maps ⁷	-	-	-	●
Chevrolet Infotainment 3 Plus system ¹ with Navigation ⁸ and 8-inch diagonal HD color touch-screen, AM/FM stereo, Bluetooth audio streaming ² for two active devices, voice command pass-through to compatible phone, wireless Apple CarPlay ³ and wireless Android Auto ⁴ compatibility, available Alexa Built-In ⁵ ; enhanced voice recognition, available In-Vehicle Apps ⁶ and Connected Navigation ⁹ (requires available Infotainment Package, Confidence & Convenience Package and Advanced Safety Package on LT; requires available Infotainment Package and Advanced Safety Package on RS; requires available Infotainment II Package and Confidence & Convenience II Package on Premier)	-	○	○	○
Audio – 6-speaker system	●	●	●	●
– 7-speaker Bose premium audio system (requires available RS Leather Package on RS; requires available Infotainment II Package and Confidence & Convenience II Package on Premier)	-	-	○	○
Media – USB ports; ¹⁰ one Type-A and one Type-C, and auxiliary input jack in front storage bin	●	●	●	-
– USB ports; ¹⁰ one Type-A and one Type-C, SD card reader and auxiliary input jack in front storage bin (requires available Infotainment Package, Confidence & Convenience Package and Advanced Safety Package on LT; requires available Infotainment Package and Advanced Safety Package on RS)	-	○	○	●
– USB ports; ¹⁰ two Type-A, in floor console storage bin (requires available Infotainment Package, Confidence & Convenience Package and Advanced Safety Package on LT; requires available Infotainment Package and Advanced Safety Package on RS)	-	○	○	●
– USB ports; ¹⁰ two Type-A, charge-only, on rear of center console	●	●	●	●
SiriusXM ^{®11} – 3-month trial subscription	●	●	●	●
Available Wi-Fi [®] Hotspot ¹² for up to seven devices, includes 1 month of unlimited data	○	○	○	○
Chevrolet Connected Access ¹³ with up to 10 years of standard connectivity, which currently enables features such as Vehicle Diagnostics and Dealer Maintenance Notification	●	●	●	●
Wireless charging ¹⁴	-	-	-	●

¹ Chevrolet Infotainment System functionality varies by model. Full functionality requires compatible Bluetooth and smartphone, and USB connectivity for some devices. ² Go to my.chevrolet.com/learnAbout/bluetooth to find out which phones are compatible with the vehicle. Full Bluetooth feature functionality varies by device, model and software version. ³ Vehicle user interface is a product of Apple and its terms and privacy statements apply. Requires compatible iPhone and data plan rates apply. ⁴ Vehicle user interface is a product of Google and its terms and privacy statements apply. Requires the Android Auto app on Google Play and a compatible Android smartphone. Data plan rates apply. You can check which smartphones are compatible at g.co/androidauto/requirements. ⁵ Functionality is subject to limitations and varies by vehicle, infotainment system and location. Select service plan required. Certain Alexa Skills require account linking to use. Visit onstar.com for additional details. ⁶ Third-party trademarks are the property of their respective third-party owners and used under agreement. Requires active service plan and paid AT&T vehicle data plan. Visit onstar.com for details and limitations. ⁷ U.S. only. Requires select service plan. Functionality is subject to user terms and limitations and varies by vehicle model. Visit onstar.com for details and limitations. ⁸ Map coverage available in the United States, Puerto Rico and Canada. Visit onstar.com for details and limitations. ⁹ Connected Navigation and Real-time Points of Interest (POI) only available on properly equipped vehicles. Requires paid plan or trial. Map coverage available in the United States, Puerto Rico and Canada. Visit onstar.com for details and limitations. ¹⁰ Not compatible with all devices. ¹¹ If you decide to continue service after your trial, your selected subscription plan will automatically renew thereafter. You will be charged at then-current rates. Fees and taxes apply. To cancel you must call SiriusXM at 1-866-635-2349. See SiriusXM Customer Agreement for complete terms at siriusxm.com. All fees and programming subject to change. ¹² Service varies with conditions and location. Requires active service and paid AT&T data plan. Visit onstar.com for details and limitations. Availability subject to change. ¹³ Standard connectivity available only to original purchaser for up to 10 years. Connected Access services are subject to change. Does not include emergency or security services. Diagnostic capabilities vary by model and service plan. Message and data rates may apply. Requires contact method on file and enrollment to receive alerts. Not all issues will deliver alerts. Visit onstar.com for details and limitations. ¹⁴ The system wirelessly charges one compatible mobile device. Some phones have built-in wireless charging technology and others require a special adaptor/back cover. To check for phone or other device compatibility, visit my.chevrolet.com/learn or consult your carrier.

SPECIFICATIONS (CONTINUED)

● STANDARD ○ AVAILABLE – NOT AVAILABLE

	LS	LT	RS	PREMIER
PACKAGES				
LS Convenience Package	○	–	–	–
Driver 8-way power seat adjuster with 2-way power lumbar control, Driver Information Center with enhanced multi-color display and deep-tinted rear glass				
Driver Confidence II Package	○	○	●	–
Rear Cross Traffic Alert ¹ and Lane Change Alert with Side Blind Zone Alert ¹ ; includes Rear Park Assist ¹ on LS; includes Front and Rear Park Assist ¹ on LT and RS (requires available Confidence & Convenience Package on LT)				
Confidence & Convenience Package	–	○	●	–
Driver Confidence II Package (Rear Cross Traffic Alert ¹ ; Lane Change Alert with Side Blind Zone Alert ¹ ; and Front and Rear Park Assist ¹) and Driver Convenience Package (remote vehicle starter system, dual-zone automatic climate control, leather-wrapped steering wheel, programmable power liftgate and heated front seats [feature will not function on certain models without dealer retrofit; see dealer or window label for details])				
Advanced Safety Package	–	○	○	–
HD Surround Vision ¹ , Adaptive Cruise Control ¹ and outside heated power-adjustable manual-folding mirrors with integrated turn signal indicators (requires available Confidence & Convenience Package and Infotainment Package on LT; requires available Infotainment Package on RS)				

	LS	LT	RS	PREMIER
PACKAGES (CONTINUED)				
Infotainment Package	–	○	○	–
Chevrolet Infotainment 3 Plus system ² with Navigation ³ and 8-inch diagonal HD color touch-screen, two USB ports ⁴ (one Type-A and one Type-C), SD card reader and auxiliary input jack in front storage bin, two USB ports ⁴ (Type-A) in floor console storage bin, heated steering wheel, and 120-volt power outlet on rear of center console (requires available Confidence & Convenience Package and Advanced Safety Package on LT; requires available Advanced Safety Package on RS)				
RS Leather Package	–	–	○	–
Jet Black perforated leather-appointed seating with Red accents, 7-speaker Bose premium audio system and driver seatback pocket (requires available Advanced Safety Package and Infotainment Package)				
Confidence & Convenience II Package	–	–	–	○
Driver Confidence III Package (Automatic Parking Assist ¹ ; HD Surround Vision ¹ and Adaptive Cruise Control ¹) and Driver Convenience II Package (front passenger 8-way power seat adjuster with 2-way power lumbar control, ventilated front seats [models built on or after November 15, 2021, ventilated front seats will not function without dealer retrofit, expected Q2 2022; see dealer for details] and heated rear outboard seating positions [feature will not function on certain models without dealer retrofit; see dealer or window label for details])				
Infotainment II Package	–	–	–	○
Chevrolet Infotainment 3 Plus system ² with Navigation ³ and 8-inch diagonal HD color touch-screen and 7-speaker Bose premium audio system (requires available Confidence & Convenience II Package)				

¹ Safety or driver assistance features are no substitute for the driver's responsibility to operate the vehicle in a safe manner. Read the vehicle Owner's Manual for important feature limitations and information. ² Chevrolet Infotainment System functionality varies by model. Full functionality requires compatible Bluetooth and smartphone, and USB connectivity for some devices. ³ Map coverage available in the United States, Puerto Rico and Canada. ⁴ Not compatible with all devices.

SPECIFICATIONS (CONTINUED)

MAXIMUM CAPACITIES

Fuel tank (approximate)	14.9 gallons (FWD) 15.6 gallons (AWD)
Passenger volume	103.5 cubic feet
Seating (front/rear)	Seats 2/3
Cargo volume ¹	Behind second-row seat: 29.9 cubic feet Behind front seats: 63.9 cubic feet

EPA-ESTIMATED FUEL ECONOMY

1.5L FWD	26 MPG city/31 highway/28 combined
1.5L AWD	25 MPG city/30 highway/27 combined

DIMENSIONS

A - Wheelbase	107.3"
B - Length	183.1"
C - Height	65.4"

D - Front track	62.2"
Rear track	62.2"
E - Width	72.6"

Head room (front/rear)	40.0"/38.5"
Leg room (front/rear)	40.9"/39.9"
Shoulder room (front/rear)	57.2"/55.5"
Hip room (front/rear)	54.2"/51.7"

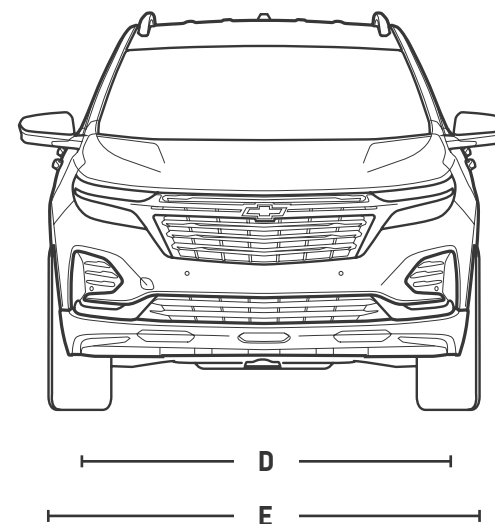
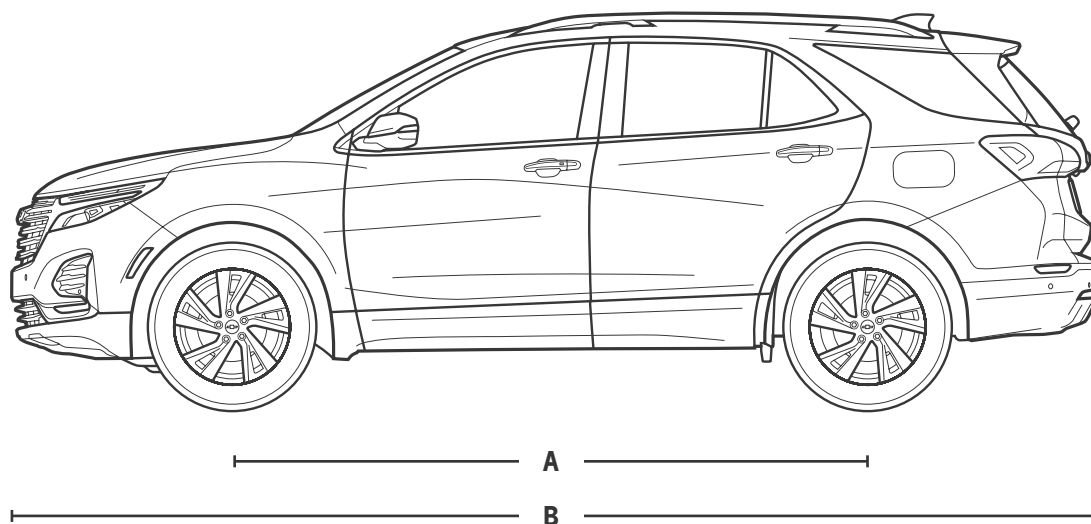

¹ Cargo and load capacity limited by weight and distribution.

ACCESSORIES



Floor Liners available from Chevrolet Accessories.



Roof Rack Cross Rails and Carrier available from Chevrolet Accessories.



Premium All-Weather Cargo Mat available from Chevrolet Accessories.



Front Illuminated Black Bowtie available from Chevrolet Accessories.

IMPORTANT INFORMATION



Every step of the way.

You may be discovering Chevrolet through a personalized online shopping experience or enjoying every year of vehicle ownership. Either way, we're committed to providing the tools and programs you need to help you get the most out of your journey.

Build & Price >

Create your perfect Chevrolet from start to finish.

Chevy MyWay¹ >

Engage in a real-time virtual video experience with a Chevy product specialist.

Chevrolet Complete Care >

Enjoy an owner benefit program that provides excellent service and support from day one.

Discover My Chevrolet Rewards² >

Unlock a world of appreciation that's all about you and your Chevrolet. Start earning and redeeming today.

Limited Warranty Coverage >

Discover all the ways Chevrolet is committed to providing an excellent ownership experience.



GM, the GM logo, Chevrolet, the Chevrolet logo, and the slogans, emblems, vehicle model names, vehicle body designs and other marks appearing in this brochure are the trademarks and/or service marks of General Motors, its subsidiaries, affiliates or licensors. ©2022 OnStar LLC. All rights reserved. Sirius, XM, SiriusXM and all related marks and logos are trademarks of Sirius XM Radio Inc. Amazon, Alexa and all related marks are trademarks of Amazon.com, Inc. or its affiliates. The Bluetooth word mark is a registered trademark owned by Bluetooth SIG, Inc., and any use of such mark by Chevrolet is under license. Bose is a registered trademark of the Bose Corp.

©2022 General Motors. All rights reserved. March 2022

FIND NEW ROADS[™]

CHEVROLET.COM

¹ Chevy MyWay is available to anyone over 18 in the United States to access and experience via chevrolet.com/myway. ² Must be 18 years or older. Points may be earned and redeemed only at GM entities, My Chevrolet Rewards participating dealers or third party retailers in the United States (excluding Puerto Rico, the U.S. Virgin Islands or Guam). Points are not earned on taxes, fees or body shop repair orders and expire without further notice upon Member Account deactivation. Visit myChevroletrewards.com to view My GM Rewards Terms & Conditions.