

CHEVROLET



2022
TRaverse

Chevy Safety Assist – standard on every 2022 Traverse.

Traverse carries many things, but the most important will always be the people who count on it every day.

The new 2022 Traverse includes Chevy Safety Assist¹, a comprehensive suite of driver assistance features that includes Automatic Emergency Braking, Front Pedestrian Braking, Lane Keep Assist with Lane Departure Warning, Forward Collision Alert, IntelliBeam[®] and Following Distance Indicator. For added security on the road, the new Rear Pedestrian Alert¹ is standard on RS, Premier and High Country and available on LT Cloth and LT Leather. In Traverse, your peace of mind is top of mind.



Traverse Premier in Iridescent Pearl Tricoat (extra-cost color).

¹ Safety or driver assistance features are no substitute for the driver's responsibility to operate the vehicle in a safe manner. Read the vehicle Owner's Manual for important feature limitations and information.

INTRODUCING TRAVERSE

Traverse at a glance.

- Chevy Safety Assist¹, standard on all models, includes
 - Automatic Emergency Braking
 - Front Pedestrian Braking
 - Lane Keep Assist with Lane Departure Warning
 - Forward Collision Alert
 - IntelliBeam
 - Following Distance Indicator
- Refreshed exterior design
 - Restyled front and rear fascias
 - Updated roof rails
 - Four new wheel styles
 - Standard LED headlamps, taillamps and daytime running lamps
- Wireless Apple CarPlay^{®2} and wireless Android Auto^{™3} compatibility
- 8-inch diagonal Driver Information Center standard on Premier and High Country
- Automatic Stop/Start with override
- Available SkyScape[®] dual-panel sunroof and fixed rear skylight with new power rear sunscreen
- Versatile SUV with seating for seven or eight⁴
- Six models: LS, LT Cloth, LT Leather, RS, Premier and High Country
- Up to 98.2 cubic feet of maximum cargo space⁵ with second- and third-row seats folded flat
- Smart Slide[®] second-row seat
- 5,000 lbs. of maximum towing capability⁶
- Available all-wheel drive



Traverse High Country interior in Jet Black with Clove accents.



Smart Slide second-row seat.

¹ Safety or driver assistance features are no substitute for the driver's responsibility to operate the vehicle in a safe manner. Read the vehicle Owner's Manual for important feature limitations and information. ² Vehicle user interface is a product of Apple and its terms and privacy statements apply. Requires compatible iPhone and data plan rates apply. ³ Vehicle user interface is a product of Google and its terms and privacy statements apply. To use Android Auto on your car display, you'll need an Android phone running Android 6 or higher, an active data plan, and the Android Auto app. ⁴ Seating for eight is standard on LS; available on LT, RS, Premier and High Country seat seven. ⁵ Cargo and load capacity limited by weight and distribution. ⁶ With available trailering equipment. Maximum trailering ratings are intended for comparison purposes only. Before you buy a vehicle or use it for trailering, carefully review the Trailering section of the Owner's Manual. The trailering capacity of your specific vehicle may vary. The weight of passengers, cargo and options or accessories may reduce the amount you can trailer.

Apple CarPlay, iPhone, Siri and Apple Music are trademarks of Apple Inc., registered in the U.S. and other countries. Google, Android and Android Auto are trademarks of Google LLC.

MODELS

Six models to choose from.

So many choices, we're certain you'll find one to match your personality.



LS

With seating for eight and loads of standard features, LS fits your life and nearly everyone in it.

- Chevy Safety Assist¹
- 3.6L V6 engine and 9-speed automatic transmission
- Automatic Stop/Start with override
- Driver Mode Selector
- Dual-outlet exhaust with circular bright tips
- 18-inch Bright Silver-painted aluminum wheels
- Heated power-adjustable mirrors
- 8-passenger seating
- Premium Cloth seating surfaces
- Tri-zone automatic climate controls
- Tilt and telescopic steering column
- Keyless Open and Start
- Chevrolet Infotainment 3 system² with 7-inch diagonal color touch-screen
- Six USB ports³, two in each row

Midnight/Sport Edition available



LT Cloth

Prepare to take a step forward in style and driver assistance features when you select LT Cloth.

- Chrome-accented grille with chrome inserts
- Black roof rails
- Body-color mirrors with turn signal indicators
- 18-inch Bright Silver-painted aluminum wheels
- 8-way power driver seat with power lumbar control
- 7-passenger or available 8-passenger seating
- 7-passenger seating includes second-row captain's chairs
- Leather-wrapped steering wheel
- Lane Change Alert with Side Blind Zone Alert⁴
- Rear Cross Traffic Alert⁴

Midnight/Sport Edition available



LT Leather

Comfort and convenience surround you from the moment you step inside Traverse LT Leather.

- Programmable power liftgate
- Remote vehicle starter system
- 7-passenger or available 8-passenger seating
- Leather-appointed front and second-row seating surfaces
- 6-way power front passenger seat with power lumbar control
- Chevrolet Infotainment 3 Plus system² with 8-inch diagonal color touch-screen
- Enhanced Driver Information Center with 4.2-inch diagonal multi-color display
- Universal Home Remote programmable transmitter

Midnight/Sport Edition available

¹ Chevy Safety Assist includes Automatic Emergency Braking, Front Pedestrian Braking, Lane Keep Assist with Lane Departure Warning, Forward Collision Alert, IntelliBeam and Following Distance Indicator. Safety or driver assistance features are no substitute for the driver's responsibility to operate the vehicle in a safe manner. Read the vehicle Owner's Manual for important feature limitations and information. ² Chevrolet Infotainment System functionality varies by model. Full functionality requires compatible Bluetooth and smartphone, and USB connectivity for some devices. ³ Not compatible with all devices. ⁴ Safety or driver assistance features are no substitute for the driver's responsibility to operate the vehicle in a safe manner. Read the vehicle Owner's Manual for important feature limitations and information.

Six models to choose from.

So many choices, we're certain you'll find one to match your personality.



RS

RS brings street-smart style, additional driver assistance features and so much more to your world.

- Black Chevrolet bowtie emblems, Traverse badges, grille, fog lamp bezels and window trim
- 20-inch dark aluminum wheels
- Heated power-adjustable, power-folding mirrors
- Exclusive Jet Black interior with Spice Red accents
- Perforated leather-appointed front and second-row seating surfaces
- Adaptive Cruise Control¹
- Enhanced Automatic Emergency Braking¹
- HD Surround Vision¹
- Rear Camera Mirror¹ with washer
- Rear Pedestrian Alert¹
- Bose premium 10-speaker sound system
- Chevrolet Infotainment 3 Plus system² with Navigation³ and 8-inch diagonal HD color touch-screen



Premier

Premier welcomes you with interior and exterior features that define sophistication.

- 20-inch metallic machined-face aluminum wheels
- Dual-outlet exhaust with rectangular bright tips
- Hands-free programmable power liftgate
- Chrome door handles and roof rails
- Body-color moldings with chrome inserts
- Exclusive Jet Black interior with Maple Sugar accents
- Safety Alert Seat¹
- Power tilt and telescopic steering column
- Enhanced Driver Information Center with 8-inch diagonal multi-color display

Redline Edition available



High Country

When you want everything Traverse has to offer, look no further than High Country.

- Trailering equipment including heavy-duty cooling system, trailer hitch and Hitch Guidance with Hitch View¹
- Exclusive chrome grille
- Heated and ventilated front seats
- 20-inch polished-aluminum wheels
- Bright front sill plates
- SkyScape dual-panel sunroof and fixed rear skylight with power rear sunscreen
- Exclusive Jet Black interior with Clove accents
- Floor mats with High Country logo on front mats

¹ Safety or driver assistance features are no substitute for the driver's responsibility to operate the vehicle in a safe manner. Read the vehicle Owner's Manual for important feature limitations and information. ² Chevrolet Infotainment System functionality varies by model. Full functionality requires compatible Bluetooth and smartphone, and USB connectivity for some devices. ³ Map coverage available in the United States, Puerto Rico and Canada.

LS EXTERIOR COLORS



Summit White



Silver Ice Metallic



Northsky Blue Metallic



Mosaic Black Metallic

LS FEATURES



Select standard features:

MECHANICAL

Engine – 3.6L DOHC V6 with Variable Valve Timing (VVT), Direct Injection and Automatic Stop/Start with override

Transmission – 9-speed automatic, electronically controlled with overdrive and Driver Shift Control

EXTERIOR

Glass – deep-tinted rear windows and liftgate

Headlamps – LED, automatic on/off with automatic delay

Liftgate – manual

Mirrors – heated, power-adjustable, manual-folding with Black caps

INTERIOR

Air conditioning – automatic, tri-zone with humidity sensor and individual climate settings for driver, front passenger and rear passengers

Audio – 6-speaker system

Cruise control – electronic with Set and Resume Speed

Entertainment – Chevrolet Infotainment 3 system¹ with 7-inch diagonal color touch-screen

Keyless Open and Start – includes extended-range Remote Keyless Entry and panic feature

Media – two USB ports² in first row, auxiliary input jack in front center stack storage area, two charge-only USB ports² in second row and two charge-only USB ports² in third row

Rear Vision Camera³

Seat – driver 6-way manual adjuster

Seating – 8-passenger with front bucket seats and second- and third-row manual-folding 60/40 split-bench seats

SiriusXM^{®4} – 3-month trial subscription

Steering column – manual tilt and telescopic

Steering wheel – 3-spoke with mounted audio, cruise and phone controls



Jet Black/Chai Premium Cloth



18" Bright Silver-Painted Aluminum Wheels
Standard on LS



18" Gloss Black-Painted Aluminum Wheels
Available on LS with Midnight/Sport Edition

¹ Chevrolet Infotainment System functionality varies by model. Full functionality requires compatible Bluetooth and smartphone, and USB connectivity for some devices. ² Not compatible with all devices. ³ Safety or driver assistance features are no substitute for the driver's responsibility to operate the vehicle in a safe manner. Read the vehicle Owner's Manual for important feature limitations and information. ⁴ If you decide to continue service after your trial, your selected subscription plan will automatically renew thereafter. You will be charged at then-current rates. Fees and taxes apply. To cancel you must call SiriusXM at 1-866-635-2349. See SiriusXM Customer Agreement for complete terms at siriusxm.com. All fees and programming subject to change.

LT CLOTH EXTERIOR COLORS



Summit White



Iridescent Pearl Tricoat¹



Silver Ice Metallic



Silver Sage Metallic



Cherry Red Tintcoat¹



Black Cherry Metallic



Northsky Blue Metallic



Mosaic Black Metallic

¹Extra-cost color.

LT CLOTH FEATURES



Select standard features:

EXTERIOR

Glass – deep-tinted rear windows and liftgate

Headlamps – LED, automatic on/off with automatic delay

Liftgate – manual

Mirrors – heated, power-adjustable, manual-folding with body-color caps and integrated turn signal indicators

Roof rails – Black

INTERIOR

Air conditioning – automatic, tri-zone with humidity sensor and individual climate settings for driver, front passenger and rear passengers

Audio – 6-speaker system

Cruise control – electronic with Set and Resume Speed

Entertainment – Chevrolet Infotainment 3 system¹ with 7-inch diagonal color touch-screen

Keyless Open and Start – includes extended-range Remote Keyless Entry and panic feature

Lane Change Alert with Side Blind Zone Alert²

Rear Cross Traffic Alert²

Rear Vision Camera²

Seat – driver 8-way power adjuster with power lumbar control

Seating – 7-passenger with front bucket seats, second-row captain's chairs and third-row manual-folding 60/40 split-bench seat

SiriusXM^{®3} – 3-month trial subscription

Steering column – manual tilt and telescopic

Steering wheel – 3-spoke, leather-wrapped with mounted audio, cruise and phone controls

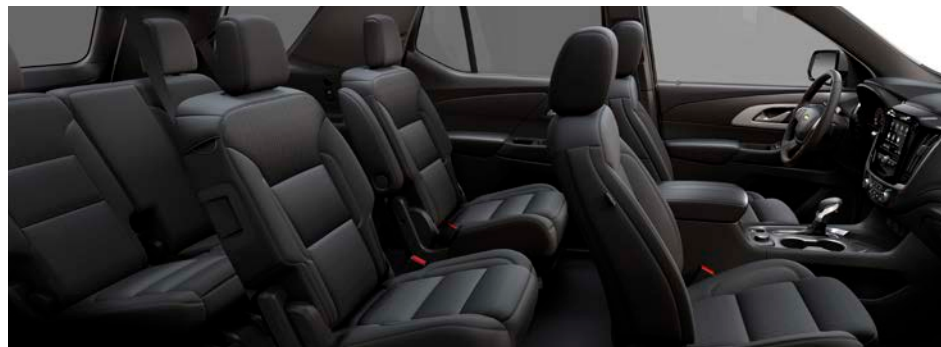

Jet Black/Chai Premium Cloth

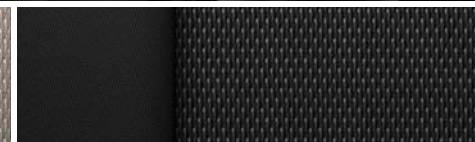

Jet Black Premium Cloth (shown)



18" Bright Silver-Painted Aluminum Wheels
Standard on LT Cloth



18" Gloss Black-Painted Aluminum Wheels
Available on LT Cloth with Midnight/Sport Edition

¹ Chevrolet Infotainment System functionality varies by model. Full functionality requires compatible Bluetooth and smartphone, and USB connectivity for some devices. ² Safety or driver assistance features are no substitute for the driver's responsibility to operate the vehicle in a safe manner. Read the vehicle Owner's Manual for important feature limitations and information. ³ If you decide to continue service after your trial, your selected subscription plan will automatically renew thereafter. You will be charged at then-current rates. Fees and taxes apply. To cancel you must call SiriusXM at 1-866-635-2349. See SiriusXM Customer Agreement for complete terms at siriusxm.com. All fees and programming subject to change.

LT LEATHER EXTERIOR COLORS



Summit White



Iridescent Pearl Tricoat¹



Silver Ice Metallic



Silver Sage Metallic



Cherry Red Tintcoat¹



Black Cherry Metallic



Northsky Blue Metallic



Mosaic Black Metallic

¹Extra-cost color.

LT LEATHER FEATURES



Select standard features:

EXTERIOR

Liftgate – power, programmable

Mirrors – heated, power-adjustable, manual-folding with body-color caps and integrated turn signal indicators

Roof rails – Black

INTERIOR

Air conditioning – automatic, tri-zone with humidity sensor and individual climate settings for driver, front passenger and rear passengers

Audio – 6-speaker system

Cruise control – electronic with Set and Resume Speed

Entertainment – Chevrolet Infotainment 3 Plus system¹ with 8-inch diagonal HD color touch-screen

HD Rear Vision Camera²

Keyless Open and Start – includes extended-range Remote Keyless Entry and panic feature

Lane Change Alert with Side Blind Zone Alert²

Rear Cross Traffic Alert²

Remote vehicle starter system

Seat – driver 8-way power adjuster with power lumbar control
– front passenger 6-way power adjuster with power lumbar control

SiriusXM[®] with 360L³ – 3-month trial subscription

Steering wheel – leather-wrapped with mounted audio, cruise and phone controls

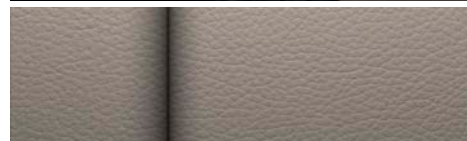

Jet Black/Chai Leather-Appointed Seating Surfaces (shown)

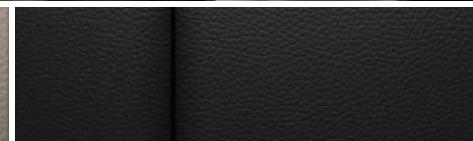

Jet Black Leather-Appointed Seating Surfaces



18" Bright Silver-Painted Aluminum Wheels
Standard on LT Leather



18" Gloss Black-Painted Aluminum Wheels
Available on LT Leather with Midnight/Sport Edition



20" Bright Machined-Face Aluminum Wheels
with Painted Pockets
Available on LT Leather with LT Premium Package

¹ Chevrolet Infotainment System functionality varies by model. Full functionality requires compatible Bluetooth and smartphone, and USB connectivity for some devices. ² Safety or driver assistance features are no substitute for the driver's responsibility to operate the vehicle in a safe manner. Read the vehicle Owner's Manual for important feature limitations and information. ³ If you decide to continue service after your trial, your selected subscription plan will automatically renew thereafter. You will be charged at then-current rates. Fees and taxes apply. To cancel you must call SiriusXM at 1-866-635-2349. See SiriusXM Customer Agreement for complete terms at siriusxm.com. All fees and programming subject to change. Certain features require a SiriusXM subscription and the Chevrolet Connected Access plan. See siriusxm.com and onstar.com for details and limitations.

Some features shown may have limited, late or no availability. See dealer for feature availability.

RS EXTERIOR COLORS



Summit White



Iridescent Pearl Tricoat¹



Silver Ice Metallic



Cherry Red Tintcoat¹



Mosaic Black Metallic

¹Extra-cost color.

RS FEATURES



Select standard features:

EXTERIOR

Liftgate – power, programmable

Mirrors – heated, power-adjustable, power-folding with body-color caps and integrated turn signal indicators

RS accents – Black accents including Black roof rails, Black Chevrolet bowtie emblems, Black Traverse badges, gloss Black window trim, and Black Ice grille and fog lamp bezels

INTERIOR

Adaptive Cruise Control¹

Audio – Bose premium 10-speaker sound system with Richbass woofer under center console

Enhanced Automatic Emergency Braking¹

Entertainment – Chevrolet Infotainment 3 Plus system² with Navigation³

HD Surround Vision¹ – includes HD Rear Vision Camera¹

Keyless Open and Start – includes extended-range Remote Keyless Entry and panic feature

Lane Change Alert with Side Blind Zone Alert¹

Power outlet – 120-volt on rear of center console

Rear Camera Mirror¹ – with washer, auto-dimming with full camera display

Rear Cross Traffic Alert¹

Rear Pedestrian Alert¹

Remote vehicle starter system

SiriusXM[®] with 360L⁴ – 3-month trial subscription

Steering wheel – leather-wrapped with mounted audio, cruise and phone controls

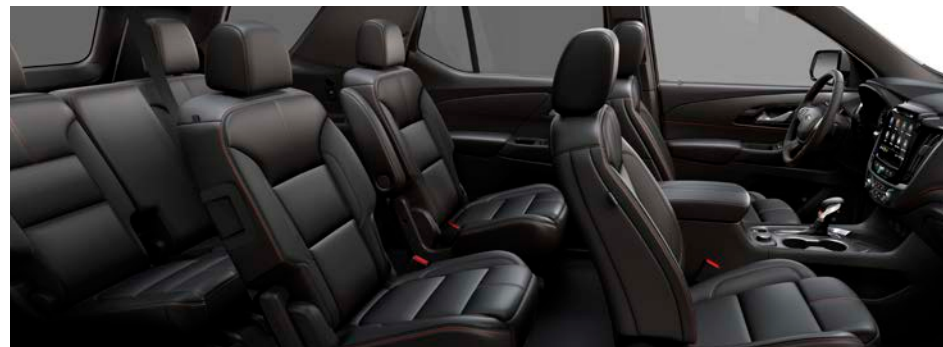

Jet Black/Spice Red Perforated Leather-Appointed Seating Surfaces



20" Dark Aluminum Wheels
Standard on RS

¹ Safety or driver assistance features are no substitute for the driver's responsibility to operate the vehicle in a safe manner. Read the vehicle Owner's Manual for important feature limitations and information. ² Chevrolet Infotainment System functionality varies by model. Full functionality requires compatible Bluetooth and smartphone, and USB connectivity for some devices. ³ Map coverage available in the United States, Puerto Rico and Canada. ⁴ If you decide to continue service after your trial, your selected subscription plan will automatically renew thereafter. You will be charged at then-current rates. Fees and taxes apply. To cancel you must call SiriusXM at 1-866-635-2349. See SiriusXM Customer Agreement for complete terms at siriusxm.com. All fees and programming subject to change. Certain features require a SiriusXM subscription and the Chevrolet Connected Access plan. See siriusxm.com and onstar.com for details and limitations.

Some features shown may have limited, late or no availability. See dealer for feature availability.

PREMIER EXTERIOR COLORS



Summit White



Iridescent Pearl Tricoat¹



Silver Ice Metallic



Cherry Red Tintcoat¹



Black Cherry Metallic



Mosaic Black Metallic

¹Extra-cost color.

PREMIER FEATURES



Select standard features:

EXTERIOR

Liftgate – power, programmable, hands-free with Chevrolet emblem projection

Mirrors – heated, power-adjustable, power-folding with body-color caps, integrated turn signal indicators and driver-side auto-dimming feature

Roof rails – chrome

INTERIOR

Adaptive Cruise Control¹

Audio – Bose premium 10-speaker sound system with Richbass woofer under center console

Enhanced Automatic Emergency Braking¹

Entertainment – Chevrolet Infotainment 3 Plus system² with Navigation³

HD Surround Vision¹ – includes HD Rear Vision Camera¹

Keyless Open and Start – includes extended-range Remote Keyless Entry and panic feature

Memory settings – recalls two presets for power driver seat, exterior mirrors, and power tilt and telescopic steering column

Rear Camera Mirror¹ – with washer, auto-dimming with full camera display

Rear Pedestrian Alert¹

Remote vehicle starter system

Safety Alert Seat¹

SiriusXM[®] with 360L⁴ – 3-month trial subscription

Steering column – power tilt and telescopic

Steering wheel – leather-wrapped with mounted audio, cruise and phone controls



Jet Black/Chai Perforated Leather-Appointed Seating Surfaces with Sueded Microfiber Inserts

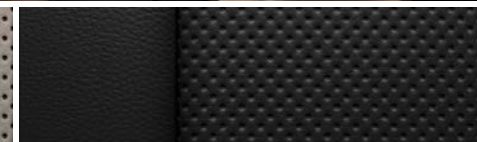

Jet Black Perforated Leather-Appointed Seating Surfaces with Sueded Microfiber Inserts



Maple Sugar Perforated Leather-Appointed Seating Surfaces with Sueded Microfiber Inserts (shown)



20" Metallic Machined-Face Aluminum Wheels
Standard on Premier



20" Gloss Black-Painted Aluminum Wheels with Red Accents
Available on Premier with Redline Edition

¹ Safety or driver assistance features are no substitute for the driver's responsibility to operate the vehicle in a safe manner. Read the vehicle Owner's Manual for important feature limitations and information. ² Chevrolet Infotainment System functionality varies by model. Full functionality requires compatible Bluetooth and smartphone, and USB connectivity for some devices. ³ Map coverage available in the United States, Puerto Rico and Canada. ⁴ If you decide to continue service after your trial, your selected subscription plan will automatically renew thereafter. You will be charged at then-current rates. Fees and taxes apply. To cancel you must call SiriusXM at 1-866-635-2349. See SiriusXM Customer Agreement for complete terms at siriusxm.com. All fees and programming subject to change. Certain features require a SiriusXM subscription and the Chevrolet Connected Access plan. See siriusxm.com and onstar.com for details and limitations.

Some features shown may have limited, late or no availability. See dealer for feature availability.

HIGH COUNTRY EXTERIOR COLORS



Summit White



Iridescent Pearl Tricoat¹



Silver Ice Metallic



Cherry Red Tintcoat¹



Black Cherry Metallic



Mosaic Black Metallic

¹Extra-cost color.

HIGH COUNTRY FEATURES



Select standard features:

EXTERIOR

Liftgate – power, programmable, hands-free with Chevrolet emblem projection

Mirrors – heated, power-adjustable, power-folding with body-color caps, integrated turn signal indicators and driver-side auto-dimming feature

Roof rails – chrome

INTERIOR

Adaptive Cruise Control¹

Audio – Bose premium 10-speaker sound system with Richbass woofer under center console

Enhanced Automatic Emergency Braking¹

Entertainment – Chevrolet Infotainment 3 Plus system² with Navigation³

HD Surround Vision¹ – includes HD Rear Vision Camera¹

Memory settings – recalls two presets for power driver seat, exterior mirrors, and power tilt and telescopic steering column

Rear Camera Mirror¹ – with washer, auto-dimming with full camera display

Rear Pedestrian Alert¹

Remote vehicle starter system

Safety Alert Seat¹

Seats – heated and ventilated driver and front passenger

SiriusXM[®] with 360L⁴ – 3-month trial subscription

Steering column – power tilt and telescopic

Steering wheel – leather-wrapped with mounted audio, cruise and phone controls

Sunroof – SkyScape, power tilt-sliding front with fixed rear skylight and sunscreen

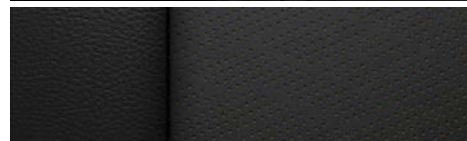
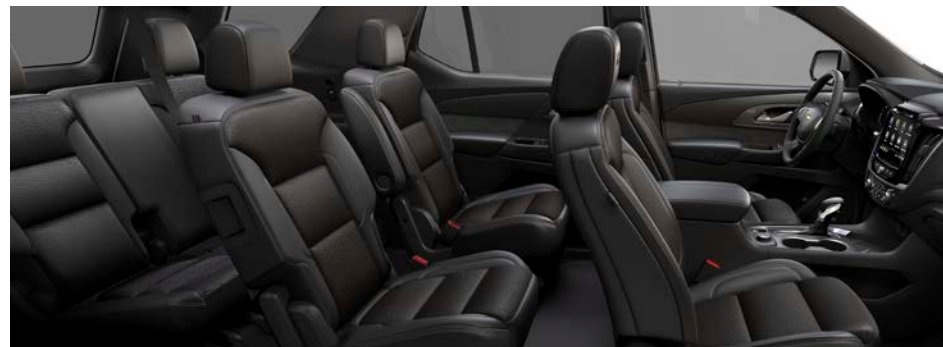

Jet Black/Clove Perforated Leather-Appointed Seating Surfaces



20" Polished-Aluminum Wheels
Standard on High Country

¹ Safety or driver assistance features are no substitute for the driver's responsibility to operate the vehicle in a safe manner. Read the vehicle Owner's Manual for important feature limitations and information. ² Chevrolet Infotainment System functionality varies by model. Full functionality requires compatible Bluetooth and smartphone, and USB connectivity for some devices. ³ Map coverage available in the United States, Puerto Rico and Canada. ⁴ If you decide to continue service after your trial, your selected subscription plan will automatically renew thereafter. You will be charged at then-current rates. Fees and taxes apply. To cancel you must call SiriusXM at 1-866-635-2349. See SiriusXM Customer Agreement for complete terms at siriusxm.com. All fees and programming subject to change. Certain features require a SiriusXM subscription and the Chevrolet Connected Access plan. See siriusxm.com and onstar.com for details and limitations.

Some features shown may have limited, late or no availability. See dealer for feature availability.

SPECIFICATIONS

● STANDARD ○ AVAILABLE – NOT AVAILABLE

	LS	LT CLOTH	LT LEATHER	RS	PREMIER	HIGH COUNTRY
SAFETY AND DRIVER ASSISTANCE						
Chevy Safety Assist ¹	●	●	●	●	●	●
Automatic Emergency Braking						
Front Pedestrian Braking						
Lane Keep Assist with Lane Departure Warning						
Forward Collision Alert						
IntelliBeam, auto high beams						
Following Distance Indicator						
Airbags ² – frontal airbags for driver and front passenger; seat-mounted side-impact airbags for driver and front passenger; driver inboard seat-mounted side-impact airbag; head-curtain airbags for all rows in outboard seating positions; includes Passenger Sensing System for passenger-side frontal and knee airbags	●	●	●	●	●	●
Enhanced Automatic Emergency Braking ¹ (requires available LT Premium Package on LT Leather)	–	–	○	●	●	●
Lane Change Alert with Side Blind Zone Alert ¹ (requires available Safety Package on LS)	○	●	●	●	●	●
LATCH system (Lower Anchors and Tethers for CHildren) – for child restraint systems	●	●	●	●	●	●
Rear Cross Traffic Alert ¹ (requires available Safety Package on LS)	○	●	●	●	●	●
Rear Park Assist ¹ (requires available Safety Package on LS; feature will not function on certain models without dealer retrofit; see dealer or window label for details)	○	○	○	○	○	○
Rear Pedestrian Alert ¹ (requires available HD Surround Vision on LT Cloth and LT Leather)	–	○	○	●	●	●
Rear Vision Camera ¹	●	●	–	–	–	–
HD Rear Vision Camera ¹ (included on LT Cloth with available AWD; requires available Convenience and Driver Confidence Package on LT Cloth FWD)	–	○	●	●	●	●
HD Surround Vision ¹ (requires available Rear Camera Mirror ¹ or Convenience and Driver Confidence Package on LT Cloth)	–	○	○	●	●	●
Safety Alert Seat ¹	–	–	–	–	●	●
Teen Driver technology	●	●	●	●	●	●
Theft-deterrent system – unauthorized entry	●	●	●	●	●	●
Tire Pressure Monitoring System – with Tire Fill Alert (does not monitor spare tire)	●	●	●	●	●	●
Up to 3 months of OnStar [®] Safety & Security coverage ³	●	●	●	●	●	●

	LS	LT CLOTH	LT LEATHER	RS	PREMIER	HIGH COUNTRY
MECHANICAL						
All-wheel drive (AWD) – on/off switchable	○	○	○	○	○	○
Brakes – 4-wheel antilock, 4-wheel disc with Duralife [®] rotors; electronic parking brake	●	●	●	●	●	●
Cooling system – heavy-duty (requires available trailering equipment on LT Cloth, LT Leather, RS and Premier)	–	○	○	○	○	●
Driver Mode Selector	●	●	●	●	●	●
Engine – 3.6L DOHC V6 with Variable Valve Timing (VVT), Direct Injection and Automatic Stop/Start with override; 310 hp @ 6800 rpm, 266 lb.-ft. of torque @ 2800 rpm	●	●	●	●	●	●
Exhaust – aluminized stainless steel	●	●	●	●	●	●
– dual-outlet with circular bright tips	●	●	●	●	–	–
– dual-outlet with rectangular bright tips	–	–	–	–	●	●
Hitch Guidance ¹ (requires available trailering equipment)	–	○	○	○	○	–
Hitch Guidance with Hitch View ¹ (requires available trailering equipment and Convenience and Driver Confidence Package on LT Cloth FWD; requires available trailering equipment on LT Cloth AWD, LT Leather, RS and Premier)	–	○	○	○	○	●
StabiliTrak [®] – Electronic Stability Control System with Traction Control; includes Hill Start Assist	●	●	●	●	●	●
Steering – power, electric variable-effort, rack-and-pinion with Active Return Assist	●	●	●	●	●	●
Suspension – front MacPherson strut	●	●	●	●	●	●
– rear 5-link, independent	●	●	●	●	●	●
Trailering equipment – heavy-duty cooling system, trailer hitch and Hitch Guidance ¹ (included on RS with available AWD; includes Hitch View ¹ with available Convenience and Driver Confidence Package on LT Cloth FWD; includes Hitch View ¹ on LT Cloth AWD, LT Leather, RS, Premier and High Country)	–	○	○	○	○	●
Transmission – 9-speed automatic, electronically controlled with overdrive and Driver Shift Control	●	●	●	●	●	●

¹ Safety or driver assistance features are no substitute for the driver's responsibility to operate the vehicle in a safe manner. Read the vehicle Owner's Manual for important feature limitations and information. ² A NOTE ON CHILD SAFETY: Always use seat belts and the correct child restraint for your child's age and size, even with airbags. Even in vehicles equipped with the Passenger Sensing System, children are safer when properly secured in a rear seat in the appropriate infant, child or booster seat. Never place a rear-facing infant restraint in the front seat of any vehicle equipped with an active frontal airbag. See your vehicle Owner's Manual and the child safety seat instructions for more safety information. ³ When you select a monthly plan within 30 days of activating your 1-month trial, you'll receive the next 2 months of the plan you select at no additional charge when you associate an approved payment method on file to your account and authorize recurring payments for your service plan. The amount and frequency of each recurring payment is based upon the service(s) and payment interval(s) you select from the options provided. After the trial expires, OnStar will automatically bill your payment method monthly at then-current standard monthly rates. Plans containing 4G LTE data will be billed every 30 days by AT&T. You may cancel at any time by pushing your blue OnStar button or calling 1-888-466-7827. May not be combined with other offers or retroactively applied. Offer subject to change.

SPECIFICATIONS (CONTINUED)

● STANDARD ○ AVAILABLE – NOT AVAILABLE

	LS	LT CLOTH	LT LEATHER	RS	PREMIER	HIGH COUNTRY
EXTERIOR						
Active aero shutters (requires available Adaptive Cruise Control on LT Leather)	–	–	○	●	●	●
Chevrolet bowtie emblems – Black (requires available Midnight/Sport Edition on LS, LT Cloth and LT Leather; requires available Redline Edition on Premier)	○	○	○	●	○	–
Daytime running lamps – LED	●	●	●	●	●	●
Door handles – body-color	●	●	●	●	–	–
– bright chrome	–	–	–	–	●	●
– Black (requires available Redline Edition)	–	–	–	–	○	–
Fuel filler – capless fueling	●	●	●	●	●	●
Glass – deep-tinted rear windows and liftgate	●	●	●	●	●	●
Headlamps – LED, automatic on/off with automatic delay	●	●	●	●	●	●
Liftgate – manual	●	●	–	–	–	–
– power, programmable (requires available Convenience and Driver Confidence Package on LT Cloth FWD; included on LT Cloth AWD)	–	○	●	●	–	–
– power, programmable, hands-free with Chevrolet emblem projection	–	–	–	–	●	●
Mirrors – heated, power-adjustable, manual-folding	●	–	–	–	–	–
– heated, power-adjustable, manual-folding with integrated turn signal indicators (requires available Safety Package on LS)	○	●	●	–	–	–
– heated, power-adjustable, power-folding with integrated turn signal indicators (requires available LT Premium Package on LT Leather)	–	–	○	●	–	–
– heated, power-adjustable, power-folding with integrated turn signal indicators and driver-side auto-dimming feature	–	–	–	–	●	●

	LS	LT CLOTH	LT LEATHER	RS	PREMIER	HIGH COUNTRY
EXTERIOR (CONTINUED)						
Moldings – Black bodyside and rocker	●	●	●	●	–	–
– body-color with chrome inserts	–	–	–	–	●	●
Roof rails – Black (requires available Midnight/Sport Edition on LS; requires available Redline Edition on Premier)	○	●	●	●	○	–
– chrome	–	–	–	–	●	●
Taillamps – LED	●	●	●	●	●	●
Tires – P255/65R18 all-season	●	●	●	–	–	–
– P255/55R20 all-season (requires available 20" bright machined-face aluminum wheels with painted pockets on LT Leather)	–	–	○	●	●	●
– compact spare	●	●	●	●	●	●
Wheels – 18" Bright Silver-painted aluminum	●	–	–	–	–	–
– 18" Bright Silver-painted aluminum	–	●	●	–	–	–
– 18" gloss Black-painted aluminum (requires available Midnight/Sport Edition)	○	○	○	–	–	–
– 20" bright machined-face aluminum with painted pockets (requires available LT Premium Package)	–	–	○	–	–	–
– 20" dark aluminum	–	–	–	●	–	–
– 20" metallic machined-face aluminum	–	–	–	–	●	–
– 20" gloss Black-painted aluminum with Red accents (requires available Redline Edition)	–	–	–	–	○	–
– 20" polished-aluminum	–	–	–	–	–	●
Wipers – front variable-speed, intermittent; rear intermittent with washer	●	●	●	●	●	●

SPECIFICATIONS (CONTINUED)

● STANDARD ○ AVAILABLE – NOT AVAILABLE

	LS	LT CLOTH	LT LEATHER	RS	PREMIER	HIGH COUNTRY
INTERIOR						
Active Noise Cancellation	●	●	●	●	●	●
Air conditioning – automatic, tri-zone with humidity sensor and individual climate settings for driver, front passenger and rear passengers	●	●	●	●	●	●
Cargo area – underfloor hidden storage	●	●	●	●	●	●
Cruise control – electronic with Set and Resume Speed – Adaptive Cruise Control ¹ (requires available LT Premium Package on LT Leather)	●	●	●	–	–	–
Door locks – power programmable with lockout protection and manual rear door child security	●	●	●	●	●	●
Driver Information Center – 3.5-inch diagonal monochromatic display (standard on LT Cloth FWD) – 4.2-inch diagonal enhanced multi-color display (requires available Convenience and Driver Confidence Package on LT Cloth FWD; standard on LT Cloth AWD) – enhanced 8-inch diagonal reconfigurable multi-color display – digital compass	●	●	–	–	–	–
Floor mats – all rows, carpeted – all rows, carpeted with High Country logo on first-row mats	●	●	●	●	●	–
Keyless Open and Start – includes extended-range Remote Keyless Entry and panic feature	●	●	●	●	●	●
Lighting – interior lighting with illuminated entry/exit, theater dimming, cargo area, first-row and second-row reading lamps, and door- and tailgate-activated switches	●	●	●	●	●	●
Memory settings – recalls two presets for power driver seat, exterior mirrors, and power tilt and telescopic steering column	–	–	–	–	●	●
Mirror – rearview, manual day/night – Rear Camera Mirror, ² auto-dimming with full camera display and camera washer (requires available Convenience and Driver Confidence Package on LT Cloth)	●	●	●	–	–	–
Power outlet – 120-volt, on rear of center console (requires available LT Premium Package on LT Leather)	–	–	○	●	●	●
Rear Seat Reminder ²	●	●	●	●	●	●
Remote vehicle starter system (requires available Convenience and Driver Confidence Package on LT Cloth FWD; standard on LT Cloth AWD)	–	○	●	●	●	●
Sill plates – front, bright	–	–	–	–	–	●
Steering column – manual tilt and telescopic – power tilt and telescopic	●	●	●	●	–	–

	LS	LT CLOTH	LT LEATHER	RS	PREMIER	HIGH COUNTRY
INTERIOR (CONTINUED)						
Steering wheel – 3-spoke with mounted audio, cruise and phone controls – leather-wrapped with mounted audio, cruise and phone controls – heated with selectable automatic activation (feature will not function on certain models without dealer retrofit; see dealer or window label for details)	●	–	–	–	–	–
Sunroof – SkyScape, power tilt-sliding front with fixed rear skylight and sunscreen (requires available LT Premium Package on LT Leather; requires available AWD on RS)	–	–	○	○	○	●
Umbrella holders – front doors	●	●	●	●	●	●
Universal Home Remote – programmable, includes garage door opener (requires available Convenience and Driver Confidence Package on LT Cloth FWD; standard on LT Cloth AWD)	–	○	●	●	●	●
Visors – driver and front passenger illuminated vanity mirrors, covered	●	●	●	●	●	●
Windows – power with driver express-up/-down and front passenger express-down	●	●	●	●	●	●
SEATING						
Seating – 8-passenger with front bucket seats and second- and third-row manual-folding 60/40 split-bench seats – 7-passenger with front bucket seats, second-row captain's chairs and third-row manual-folding 60/40 split-bench seat (third-row power-folding 60/40 split-bench seat standard on High Country; limited availability; see dealer for details)	●	○	○	–	–	–
Seat – driver 6-way manual adjuster – driver 8-way power adjuster with power lumbar control – front passenger 6-way power adjuster with power lumbar control	●	–	–	–	–	–
Seating surfaces – Premium Cloth – leather-appointed front and second rows; third row is vinyl-covered – perforated leather-appointed front and second rows; third row is vinyl-covered – premium perforated leather-appointed front and second rows; third row is vinyl-covered	●	●	–	–	–	–
Heated front seats (requires available Convenience and Driver Confidence Package on LT Cloth FWD; standard on LT Cloth AWD; feature will not function on certain models without dealer retrofit; see dealer or window label for details)	–	○	○	○	○	●
Heated second-row outboard seating positions (feature will not function on certain models without dealer retrofit; see dealer or window label for details)	–	–	–	–	○	○
Ventilated front seats (feature will not function on certain models without dealer retrofit; see dealer or window label for details)	–	–	–	–	○	●

¹ Safety or driver assistance features are no substitute for the driver's responsibility to operate the vehicle in a safe manner. Read the vehicle Owner's Manual for important feature limitations and information. ² Does not detect people or items. Always check rear seat before exiting.

SPECIFICATIONS (CONTINUED)

● STANDARD ○ AVAILABLE – NOT AVAILABLE

	LS	LT CLOTH	LT LEATHER	RS	PREMIER	HIGH COUNTRY
ENTERTAINMENT						
Chevrolet Infotainment 3 system ¹ with 7-inch diagonal color touch-screen, AM/FM stereo, Bluetooth [®] audio streaming ² for two active devices, voice command pass-through to compatible phone, and wireless Apple CarPlay ^{®3} and wireless Android Auto ^{™4} compatibility	●	●	–	–	–	–
Chevrolet Infotainment 3 Plus system ¹ with 8-inch diagonal HD color touch-screen, motorized power-up/-down screen and hidden storage, AM/FM stereo, Bluetooth audio streaming ² for two active devices, voice command pass-through to compatible phone, wireless Apple CarPlay ³ and wireless Android Auto ⁴ compatibility, available Alexa Built-In ⁵ , voice recognition and available In-Vehicle Apps ⁶ (requires available Convenience and Driver Confidence Package on LT Cloth FWD; standard on LT Cloth AWD)	–	○	●	–	–	–
Chevrolet Infotainment 3 Plus system ¹ with Navigation ⁷ and 8-inch diagonal HD color touch-screen, motorized power-up/-down screen and hidden storage, AM/FM stereo, Bluetooth audio streaming ² for two active devices, voice command pass-through to compatible phone, wireless Apple CarPlay ³ and wireless Android Auto ⁴ compatibility, available Alexa Built-In ⁵ , enhanced voice recognition, additional memory for available In-Vehicle Apps ⁶ and Connected Navigation ⁸ (requires available LT Premium Package on LT Leather)	–	–	○	●	●	●
Audio – 6-speaker system	●	●	●	–	–	–
– Bose premium 10-speaker sound system with Richbass woofer under center console (requires available LT Premium Package on LT Leather)	–	–	○	●	●	●
Media – two USB ports ⁹ in first row, auxiliary input jack in front center stack storage area, and two charge-only USB ports ⁹ in second and third rows	●	●	●	●	●	●
SiriusXM ^{®10} – 3-month trial subscription	●	●	–	–	–	–
SiriusXM with 360L ^{10,11} – 3-month trial subscription (requires available Convenience and Driver Confidence Package on LT Cloth FWD; standard on LT Cloth AWD)	–	○	●	●	●	●
Available Wi-Fi [®] Hotspot ¹² for up to seven devices, includes 1 month of unlimited data	○	○	○	○	○	○
Chevrolet Connected Access ¹³ with up to 10 years of standard connectivity, which currently enables features such as Vehicle Diagnostics and Dealer Maintenance Notification	●	●	●	●	●	●

¹ Chevrolet Infotainment System functionality varies by model. Full functionality requires compatible Bluetooth and smartphone, and USB connectivity for some devices. ² Go to my.chevrolet.com/learnAbout/bluetooth to find out which phones are compatible with the vehicle. Full Bluetooth feature functionality varies by device, model and software version. ³ Vehicle user interface is a product of Apple and its terms and privacy statements apply. Requires compatible iPhone and data plan rates apply. ⁴ Vehicle user interface is a product of Google and its terms and privacy statements apply. To use Android Auto on your car display, you'll need an Android phone running Android 6 or higher, an active data plan, and the Android Auto app. ⁵ Functionality is subject to limitations and varies by vehicle, infotainment system and location. Select service plan required. Certain Alexa Skills require account linking to use. Visit onstar.com for additional details. ⁶ Third-party trademarks are the property of their respective third-party owners and used under agreement. Requires active service plan and paid AT&T vehicle data plan. Visit onstar.com for details and limitations. ⁷ Map coverage available in the United States, Puerto Rico and Canada. ⁸ Connected Navigation and Real-time Points of Interest (POI) only available on properly equipped vehicles. Requires paid plan or trial. Map coverage available in the United States, Puerto Rico and Canada. Visit onstar.com for details and limitations. ⁹ Not compatible with all devices. ¹⁰ If you decide to continue service after your trial, your selected subscription plan will automatically renew thereafter. You will be charged at then-current rates. Fees and taxes apply. To cancel you must call SiriusXM at 1-866-635-2349. See SiriusXM Customer Agreement for complete terms at siriusxm.com. All fees and programming subject to change. ¹¹ Certain features require a SiriusXM subscription and the Chevrolet Connected Access plan. See siriusxm.com and onstar.com for details and limitations. ¹² Service varies with conditions and location. Requires active service and paid AT&T data plan. Visit onstar.com for details and limitations. Availability subject to change. ¹³ Standard connectivity available only to original purchaser for up to 10 years. Connected Access services are subject to change. Does not include emergency or security services. Diagnostic capabilities vary by model and service plan. Message and data rates may apply. Requires contact method on file and enrollment to receive alerts. Not all issues will deliver alerts. Visit onstar.com for details and limitations.

SPECIFICATIONS (CONTINUED)



Redline Edition.



Midnight Edition.



Sport Edition.

● STANDARD ○ AVAILABLE – NOT AVAILABLE

	LS	LT CLOTH	LT LEATHER	RS	PREMIER	HIGH COUNTRY
PACKAGES AND SPECIAL EDITIONS						
Safety Package¹	○	–	–	–	–	–
Lane Change Alert with Side Blind Zone Alert, Rear Cross Traffic Alert and Rear Park Assist (feature will not function on certain models without dealer retrofit; see dealer or window label for details)						
Convenience and Driver Confidence Package	–	○	–	–	–	–
Chevrolet Infotainment 3 Plus system ² ; Driver Information Center with 4.2-inch diagonal enhanced multi-color display, Universal Home Remote, remote vehicle starter system, programmable power liftgate and heated front seats (standard on LT Cloth AWD; feature will not function on certain models without dealer retrofit; see dealer or window label for details)						
LT Premium Package	–	–	○	–	–	–
20" bright machined-face aluminum wheels with painted pockets, heated power-adjustable power-folding mirrors with body-color caps and integrated turn signal indicators, Chevrolet Infotainment 3 Plus system ² with Navigation ³ ; Bose premium 10-speaker sound system with Richbass woofer under center console, Adaptive Cruise Control ¹ ; Enhanced Automatic Emergency Braking ¹ ; Rear Pedestrian Alert ¹ ; Rear Camera Mirror ¹ with washer, HD Surround Vision ¹ and 120-volt power outlet on rear of center console						
Midnight/Sport Edition	○	○	○	–	–	–
18" gloss Black-painted aluminum wheels, Black roof rails, Black Traverse badges, Black Chevrolet bowtie emblems, Black liftgate appliqué, gloss Black window surround and Black Ice grille surround (not available with LT Premium Package on LT Leather)						
Redline Edition	–	–	–	–	○	–
20" gloss Black-painted aluminum wheels with Red accents, Black Traverse badges with Red outline, Black Chevrolet bowtie emblems, Black roof rails, mirror caps and door handles, gloss Black window surround, Black-painted rocker and wheel openings with Black Ice inserts, Black Ice grille surround and license plate appliqué, SkyScape power sunroof, and trailering equipment (available with Summit White, Iridescent Pearl Tricoat, Silver Ice Metallic, Cherry Red Tintcoat or Mosaic Black Metallic exterior colors)						

¹ Safety or driver assistance features are no substitute for the driver's responsibility to operate the vehicle in a safe manner. Read the vehicle Owner's Manual for important feature limitations and information. ² Chevrolet Infotainment System functionality varies by model. Full functionality requires compatible Bluetooth and smartphone, and USB connectivity for some devices. ³ Map coverage available in the United States, Puerto Rico and Canada.

SPECIFICATIONS (CONTINUED)

MAXIMUM CAPACITIES

Fuel tank (approximate)	19.4 gallons - FWD 21.7 gallons - AWD
Passenger volume	157.1 cubic feet

Seating (first row/second row/third row)	LS seats 8 - 2/3/3 LT Cloth and LT Leather seat 7 - 2/2/3; option for 8 - 2/3/3 RS, Premier and High Country seat 7 - 2/2/3
Cargo volume ¹	Behind third-row seat - 23.0 cubic feet Behind second-row seat - 57.8 cubic feet Behind first-row seat - 98.2 cubic feet

DIMENSIONS

A - Wheelbase	120.9"
B - Length	205.9"
C - Height	70.7"

D - Front track	67.3"
Rear track	67.0"
E - Width	78.6"

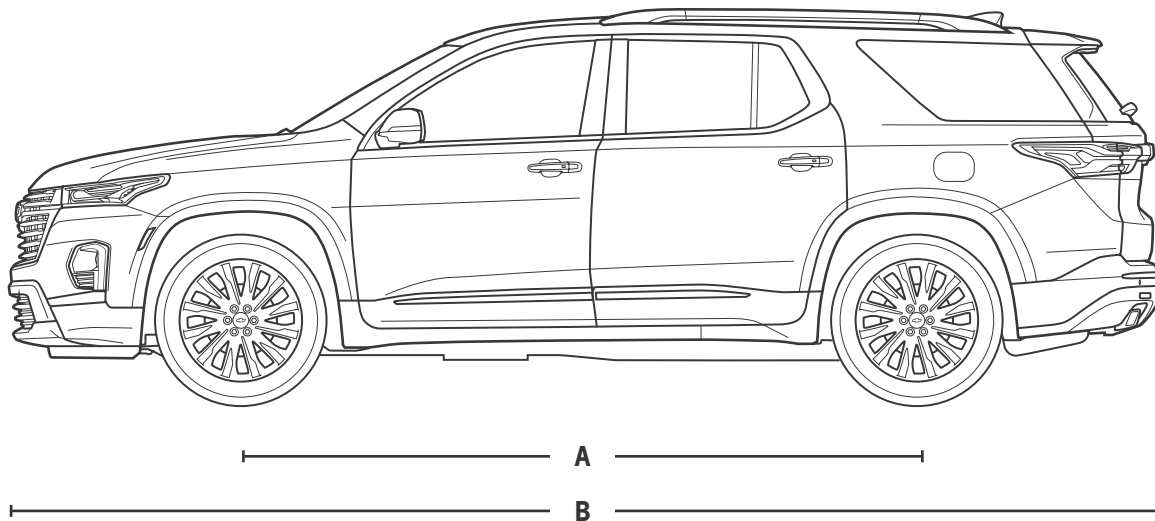

EPA-ESTIMATED FUEL ECONOMY

3.6L FWD	18 MPG city/27 highway/21 combined
3.6L AWD	17 MPG city/25 highway/20 combined

Head room (first row/second row/third row)	42.8"/40.0"/38.2"
Head room with sunroof (first row/second row/third row)	41.4"/39.0"/38.2"
Leg room (first row/second row/third row)	41.0"/38.4"/33.5"
Shoulder room (first row/second row/third row)	61.9"/62.2"/57.5"
Hip room (first row/second row/third row)	58.1"/56.9"/48.5"

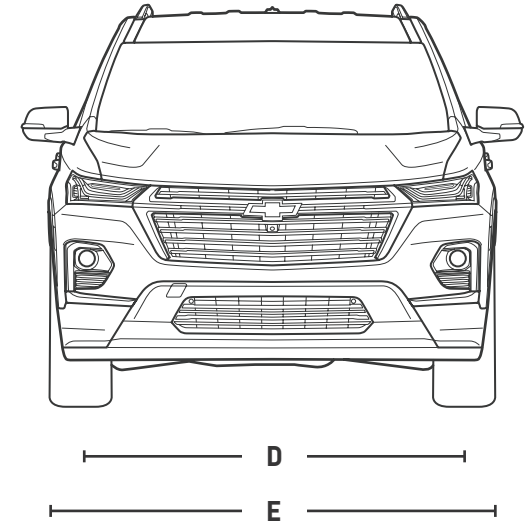

¹ Cargo and load capacity limited by weight and distribution.

ACCESSORIES



20" Chrome Finish Aluminum Split-Spoke Wheels available from Chevrolet Accessories.



Roof Rack Cross Rails available from Chevrolet Accessories.



Integrated Cargo Organizer available from Chevrolet Accessories.



Premium All-Weather Floor Liners available from Chevrolet Accessories.

IMPORTANT INFORMATION



Every step of the way.

You may be discovering Chevrolet through a personalized online shopping experience or enjoying every year of vehicle ownership. Either way, we're committed to providing the tools and programs you need to help you get the most out of your journey.

Build & Price >

Create your perfect Chevrolet from start to finish.

Chevy MyWay¹ >

Engage in a real-time virtual video experience with a Chevy product specialist.

Chevrolet Complete Care >

Enjoy an owner benefit program that provides excellent service and support from day one.

Discover My Chevrolet Rewards² >

Unlock a world of appreciation that's all about you and your Chevrolet. Start earning and redeeming today.

Limited Warranty Coverage >

Discover all the ways Chevrolet is committed to providing an excellent ownership experience.



GM, the GM logo, Chevrolet, the Chevrolet logo, and the slogans, emblems, vehicle model names, vehicle body designs and other marks appearing in this brochure are the trademarks and/or service marks of General Motors, its subsidiaries, affiliates or licensors. ©2022 OnStar LLC. All rights reserved. Sirius, XM, SiriusXM and all related marks and logos are trademarks of Sirius XM Radio Inc. Amazon, Alexa and all related marks are trademarks of Amazon.com, Inc. or its affiliates. The Bluetooth word mark is a registered trademark owned by Bluetooth SIG, Inc., and any use of such mark by Chevrolet is under license. Bose and Richbass are registered trademarks of the Bose Corp.

©2022 General Motors. All rights reserved. March 2022

FIND NEW ROADS[™]

CHEVROLET.COM

¹ Chevy MyWay is available to anyone over 18 in the United States to access and experience via chevrolet.com/myway. ² Must be 18 years or older. Points may be earned and redeemed only at GM entities, My Chevrolet Rewards participating dealers or third party retailers in the United States (excluding Puerto Rico, the U.S. Virgin Islands or Guam). Points are not earned on taxes, fees or body shop repair orders and expire without further notice upon Member Account deactivation. Visit myChevroletrewards.com to view My GM Rewards Terms & Conditions.